

porodo



**Porodo 720P High Brightness
120ANSILlumens Mini Projector**

SKU: PD-P720PJR

Table of Content

Safety Guideline	2
Accessories	2
Schematic View of Mini Projector	3
Installation Guideline	5
Specifications	6
Supporting Formats	6
Schematic View of Remote Controller	6
Powering ON/OFF	6
Default Setting	7
Focusing	8
Operation Instructions	9
1. Choosing the Input Source	9
2. Accessing Files on a USB Drive	9
3. Downloading App	10
4. Connect to WiFi	10
5. Using MaxhubShare	11
6. Using Miracast	12
7. IOS Cast	12
Bluetooth Connection	13
Projection Settings	15
1. Four-Sided Trapezoid Correction	15
2. Square Trapezoid Correction	16
3. Customized Zoom	17
4. Projection Method	17
Warranty	18
Contact Us	18

Safety Guideline

Before installing and using the product, please carefully read this User Manual to guarantee correct usage and keep it securely for future reference.

- 1 . Ensure a stable power supply. Utilize only the standard power cord provided in the package. Install the device to the power supply and cable. Choose the power supply and cable according to the specifications required by producer.
- 2 . Position the projector at a distance from couches, fabrics, and any items that may obstruct the air intake.
- 3 . It is crucial to store the device away from any flammable and explosive materials.
- 4 . Disassembling the device by yourself voids the warranty and may pose a risk to your eyesight.
- 5 . To protect your vision, avoid looking directly into the projector lens when it is on.
- 6 . The device must remain dry, away from any liquids.
- 7 . Protect against electric shock by keeping the projector in a dry environment, away from rain and moisture.
- 8 . After extensive use, especially beyond 6 consecutive hours, it is advisable to turn off the projector.
- 9 . Transport the device with the original protective foam and cushioning.
10. In the event of projector malfunction, promptly reach out to the authorized service provider for assistance.

Accessories

Remote controller x 1

Power cable x 1

User manual x 1

Schematic View of Mini Projector

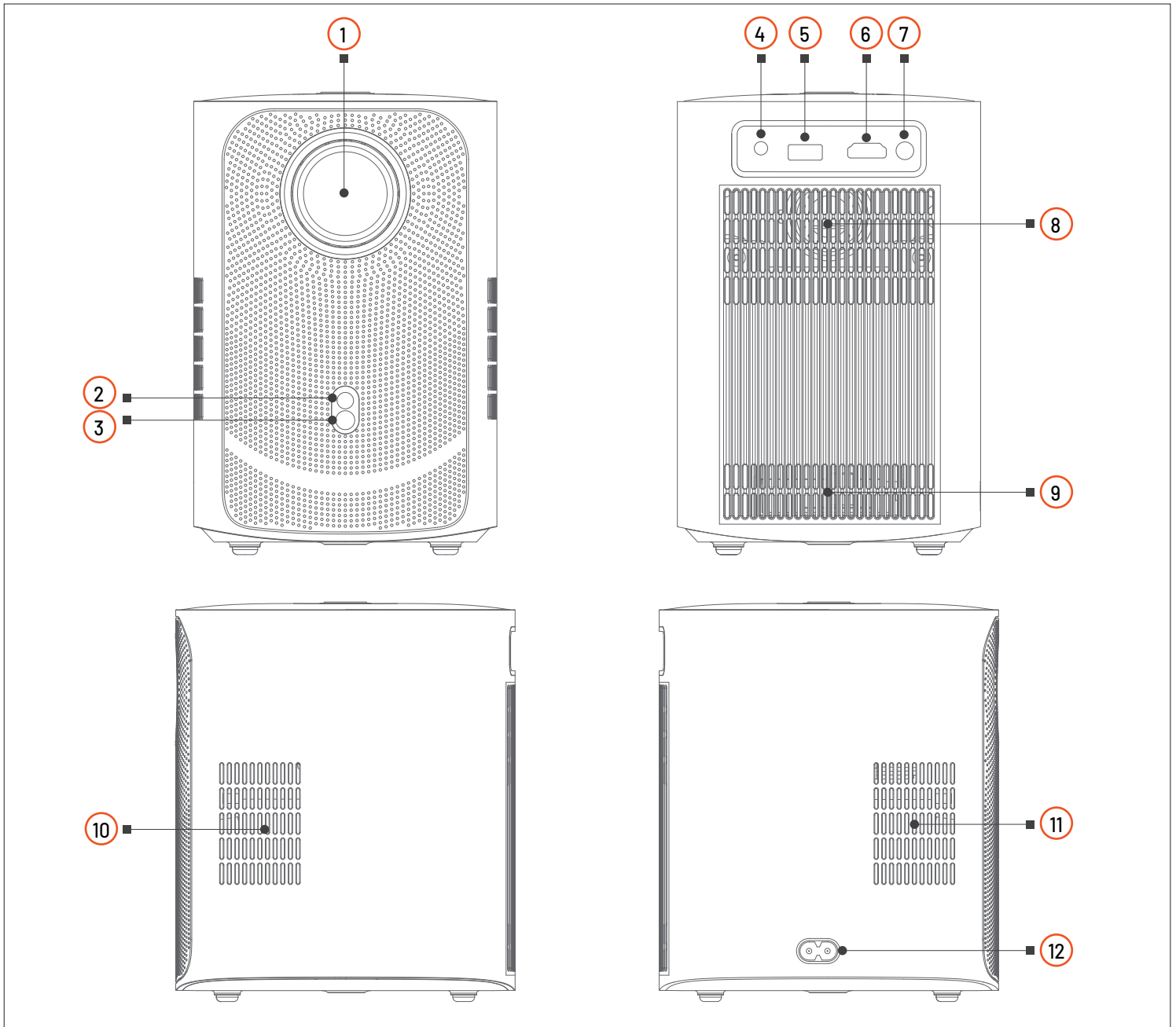

- 1 . Lens
- 2 . IR Receiver
- 3 . Camera (Available with auto focus option)
- 4 . Headphone Jack
- 5 . USB Port
- 6 . HDMI Port

- 7 . IR Receiver
- 8 . Speaker
- 9 . Air Outlet
- 10 . Cooling Window
- 11 . Cooling Window
- 12 . Power Socket

Note: To clean the dust net gently press the dust net cover and it will pop open. Take out the dust net for cleaning.

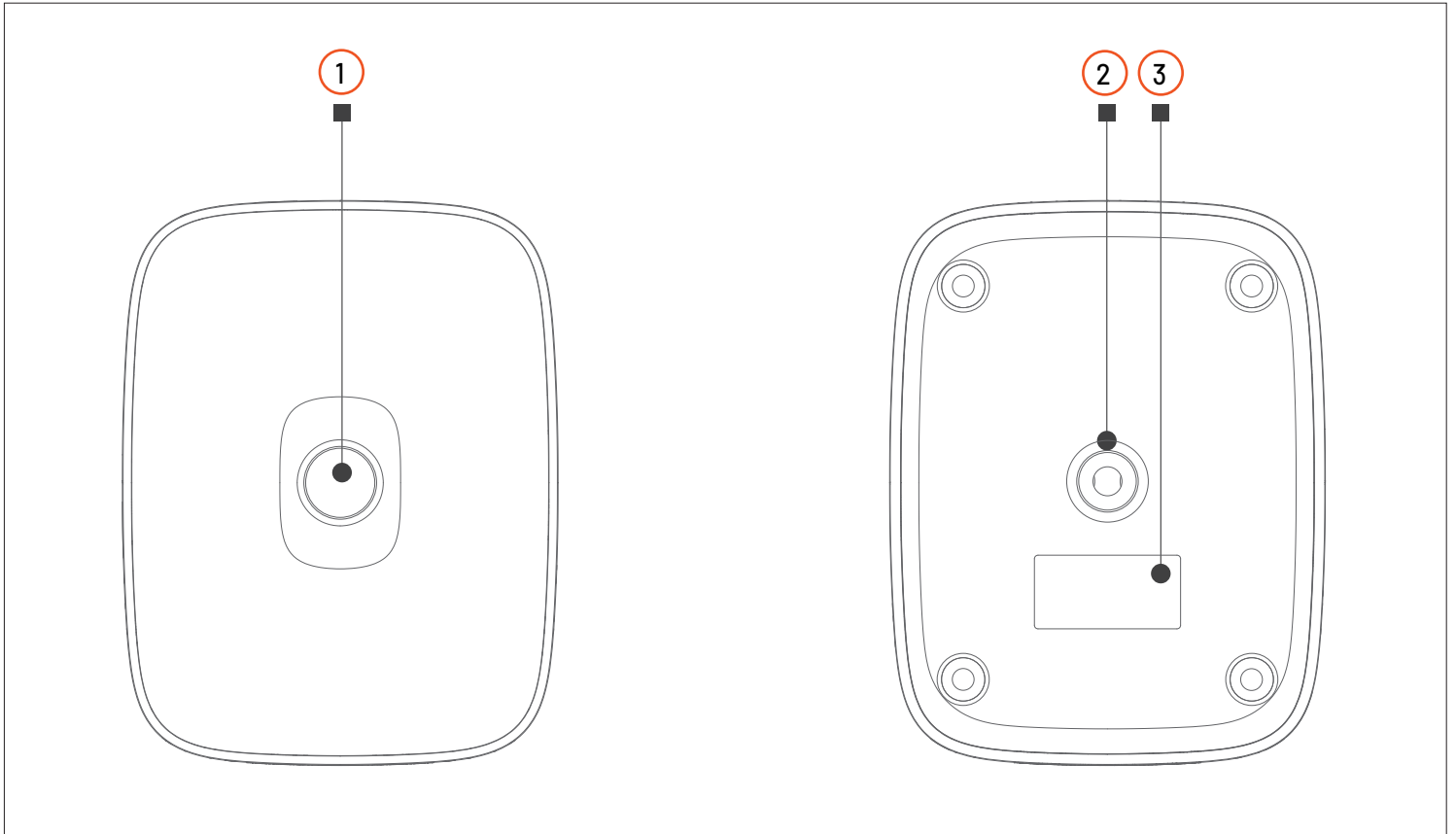

- 1 . Power Key
- 2 . Bracket Holes (1/4" - length: 6 mm)[Supports hoist]
- 3 . Bottom Label

Note: Please check the following diagram to correctly adjust the projector.

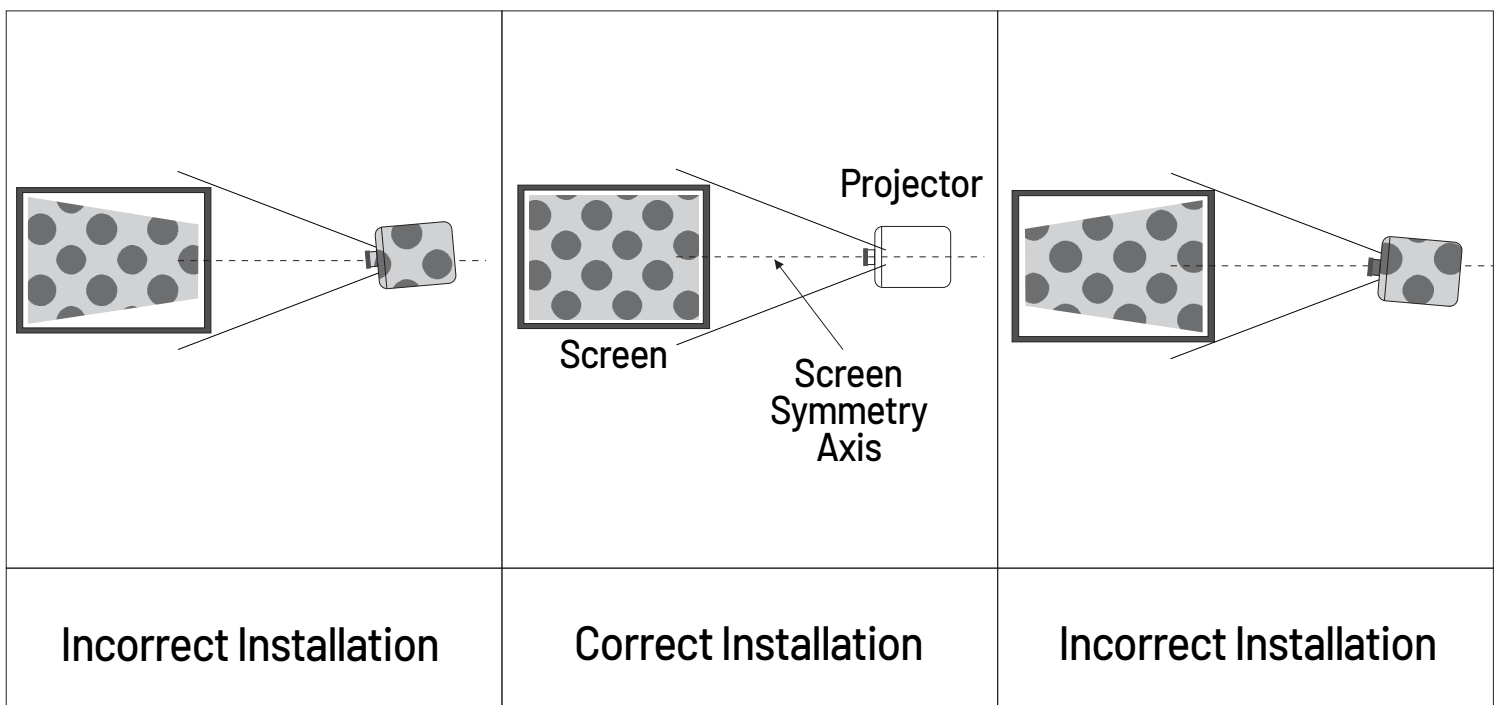

Installation Guideline

It is recommended to enlist a qualified installer for ceiling-mounting this projector. Adhere to the following directions to ensure proper positioning of the projector:

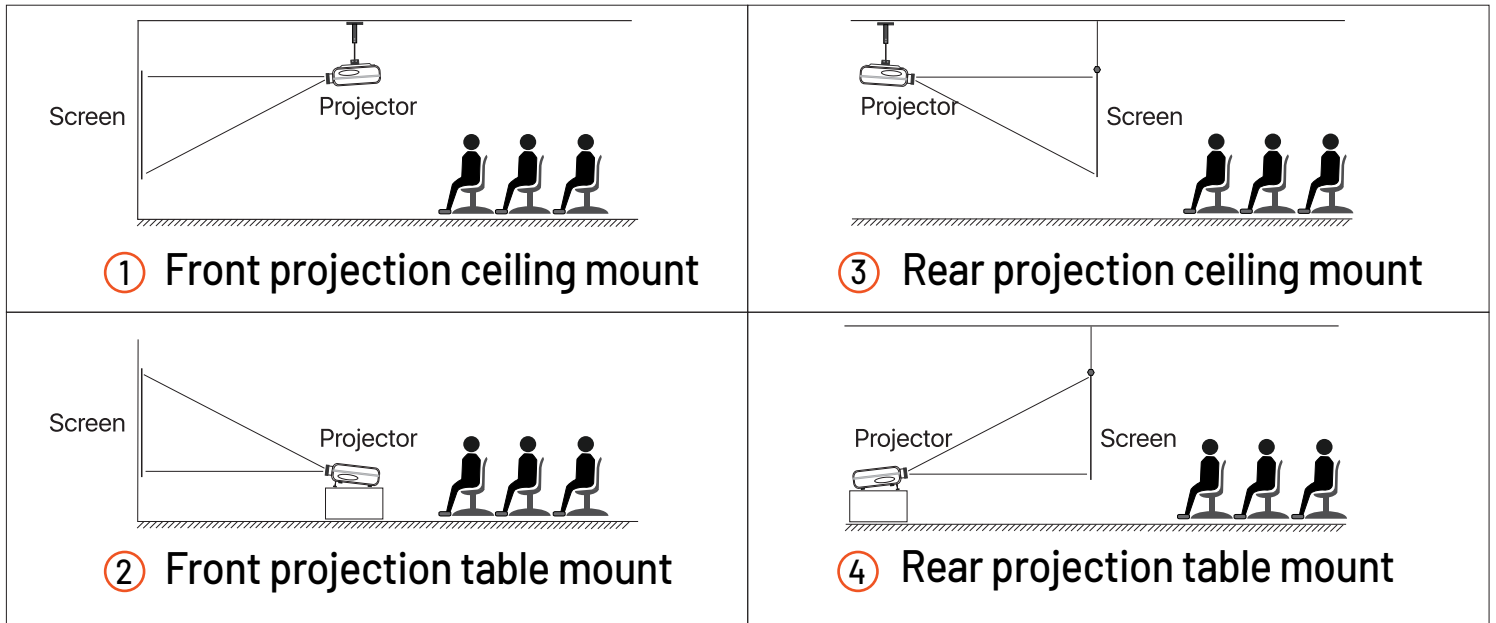

Warning

1. Improper installation of the projector onto a ceiling or surface may lead to irreparable damage.
2. Operate the projector within an ambient temperature range of 5°C to 35°C to prevent malfunction.
3. Avoid exposing the projector to dusty, wet, moist, or smoky environments to prevent operational failure.
4. Ensure adequate ventilation to prevent overheating, which could harm the projector or pose a severe safety risk.

Caution

It is prohibited to install the projector as described in the figure. The projector is portable. Transporting the device increases the risk of dropping down.

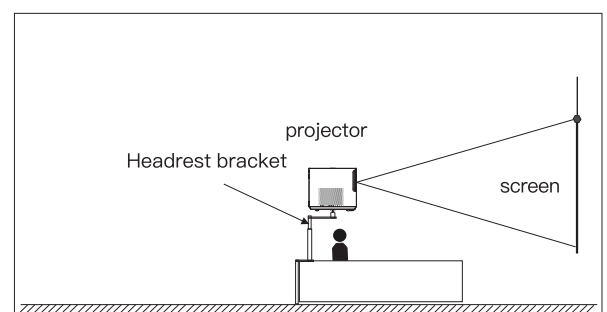

Specifications

Model	PD-P720PJR
Size	178×156×120 mm
Working Temperature	0° to 35° C
Aspect Ratio	4:3 / 16:9
Weight	1.3 kg
Input Voltage	240 - 100V AC (60/50 Hz)
Operating Mode	Manual/ Remote Control
Lamp	LED
Image System	LCD
Input Port	HDMI/USB

Supporting Formats

Image Format	JPG/ JPEG/ BMP/ PNG
Video Format	3GP/ AVI/ FLY/ MP4/ MPG/ VOB/ TS/ MZTS/ DAT/ MKY
Audio Format	MP3/ AAC/ WAV/ FLAC/ WMA/ M4A
File Format	TXT

Schematic View of Remote Controller

- 1 . Signal Indicator
- 2 . Power Key
- 3 . Arrow Key
- 4 . Home Key
- 5 . Return Key
- 6 . Increase Volume (+)
- 7 . Decrease Volume (-)
- 8 . Source Key
- 9 . Confirmation Key
- 10 . Menu
- 11 . Mute Key
- 12 . Increase Focus (+)
- 13 . Decrease Focus (-)
- 14 . Flip Screen

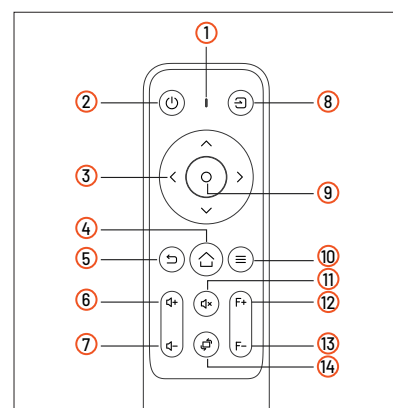

Powering ON/OFF

Power ON

Step 1: Press the power button on the projector or the corresponding button on

the remote control. The indicator light will illuminate in a steady “blue” color.

Step 2: Within 2 seconds, the projector begins its startup process, the image will be projected onto the screen, and the projector will enter its standard operating mode.

Step 3: For projectors that are being used for the first time, initial images may appear blurry or exhibit keystone distortion. Please consult the “Focusing” section of the manual for proper calibration.

Step 4: After performing adjustments, the image will be viewed with suitable clarity.

Power OFF

Step 1: To turn off the projector, press the power button on the projector or use the remote controller to initiate standby mode.

Step 2: Once the projector transitions to standby mode, it will begin an automatic heat dissipation process, and the indicator light will shift from “blue” to “red”.

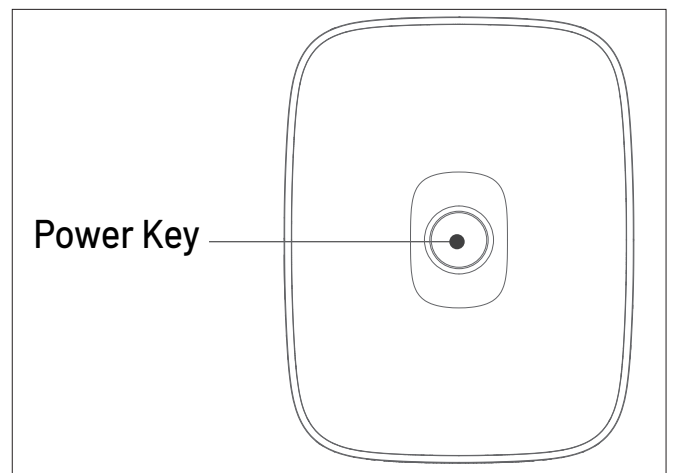

Caution

Connect the power cable to the projector before connecting the cable to an electrical outlet.

Default Setting

1. Refer to data in the table to determine the appropriate distance to place the projector from the screen for the desired image size.
2. Ensure that the projector is situated on a solid, stable surface.
3. The unit should be well-ventilated; do not cover or obstruct the air vents.
4. Maintain a clear space of at least 30 cm around the vent area to ensure proper air circulation.

Aspect Ratio	16:9
Picture Size (inch)	Projection Distance (m)
50	1.48
80	2.30
100	2.86
120	3.40

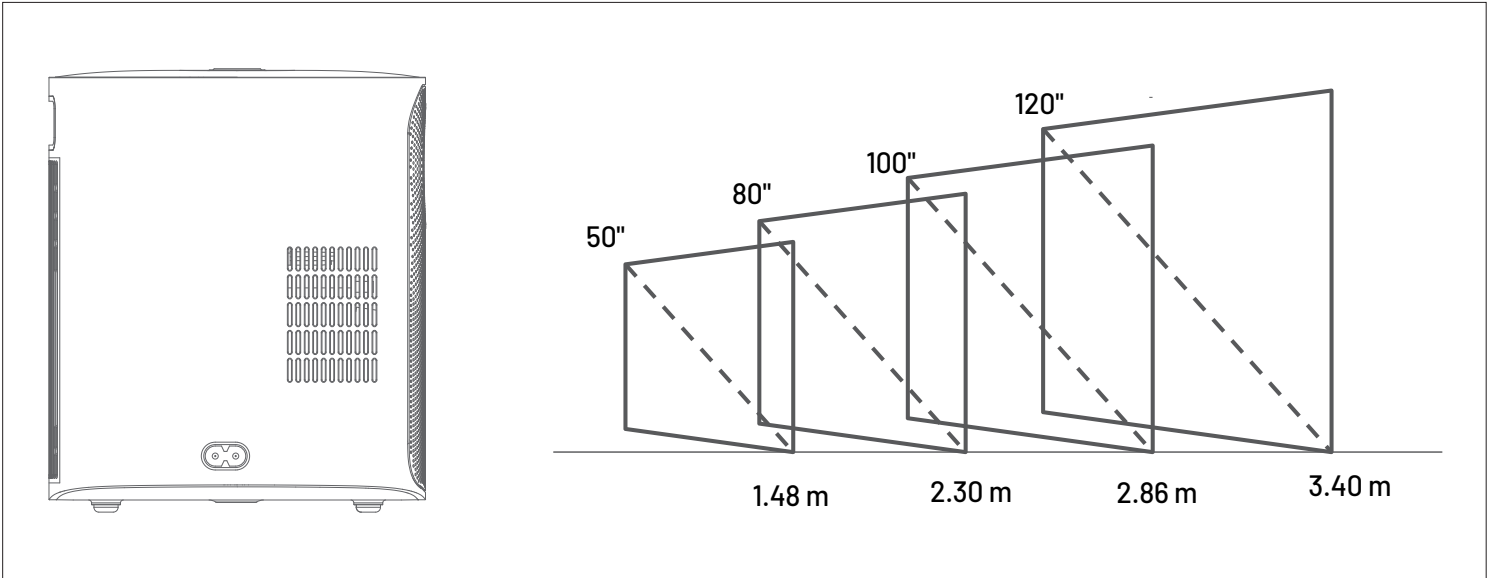

Focusing

Upon first use of the newly installed projector, the image may appear blurry which requires the user to adjust the focus setting. To increase the clarity of the image use the "F+" and "F-" focus keys on the remote control to fine-tune the lens's focal length. Press or hold the focus button until the image resolves into clarity.

Note: The auto-focus feature is exclusive to models with an auto-focus capability. Avoid obstructing the camera lens during the auto-focusing process.

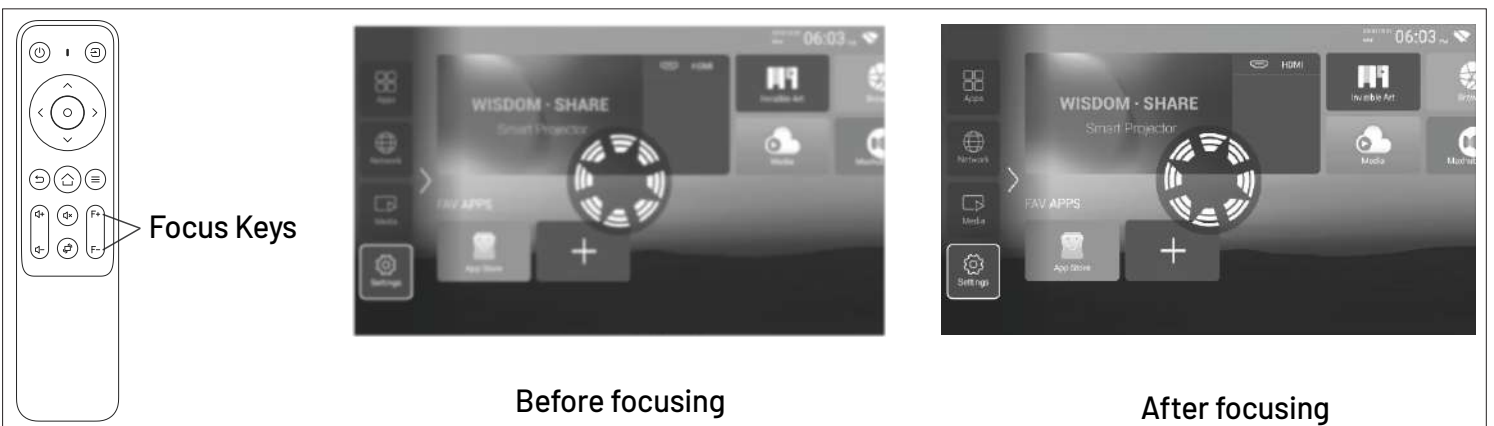

Operation Instructions

1 . Choosing the Input Source

Step 1: Power on the projector and open the main menu interface.

Step 2: Navigate to the input source selection, choose the desired signal source, and establish the connection.



2 . Accessing Files on a USB Drive

Step 1: Insert the USB drive and select "Media" from the home screen menu.

Step 2: Once in the Media interface, locate your USB drive, then browse and select the file you wish to play from the categorized list.

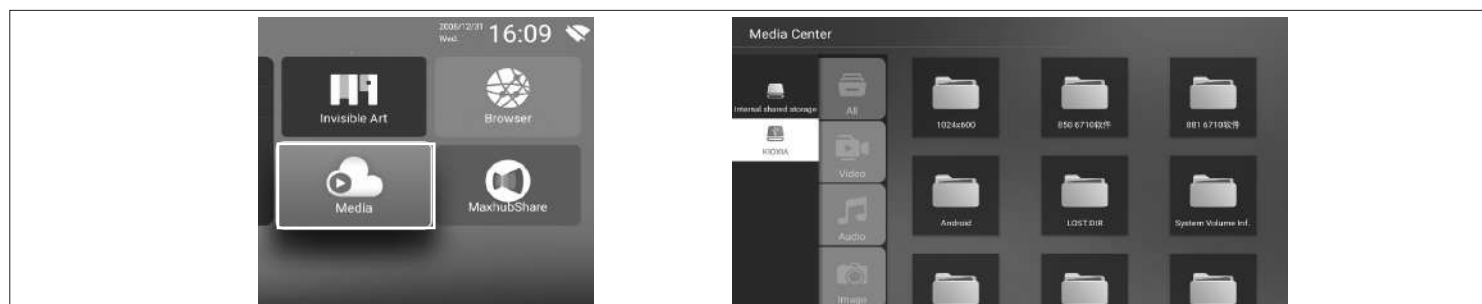

3. Downloading App

Step 1: Navigate to the App Store icon located at the bottom of the main interface, open it, and browse for the applications you wish to download.

Step 2: Add new apps by selecting the "+" sign adjacent to the App Store icon.

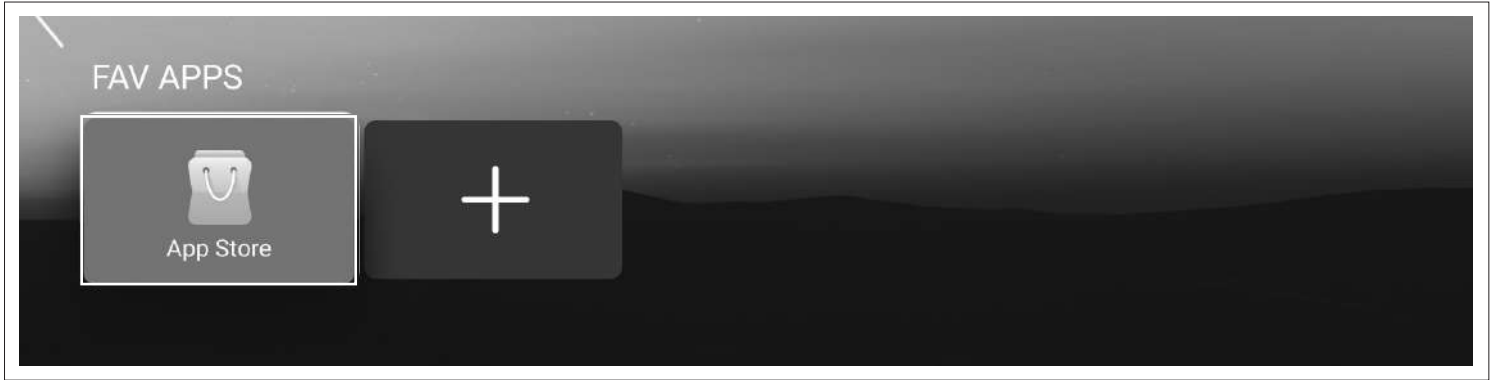

4. Connect to WiFi

Step 1: From the main interface, go to "Network" and then choose "Wireless" on the left-hand side menu.

Step 2: Search for available WiFi networks, select the desired network to connect to, input the password using the on-screen keyboard, and press "Confirm" to establish the connection.

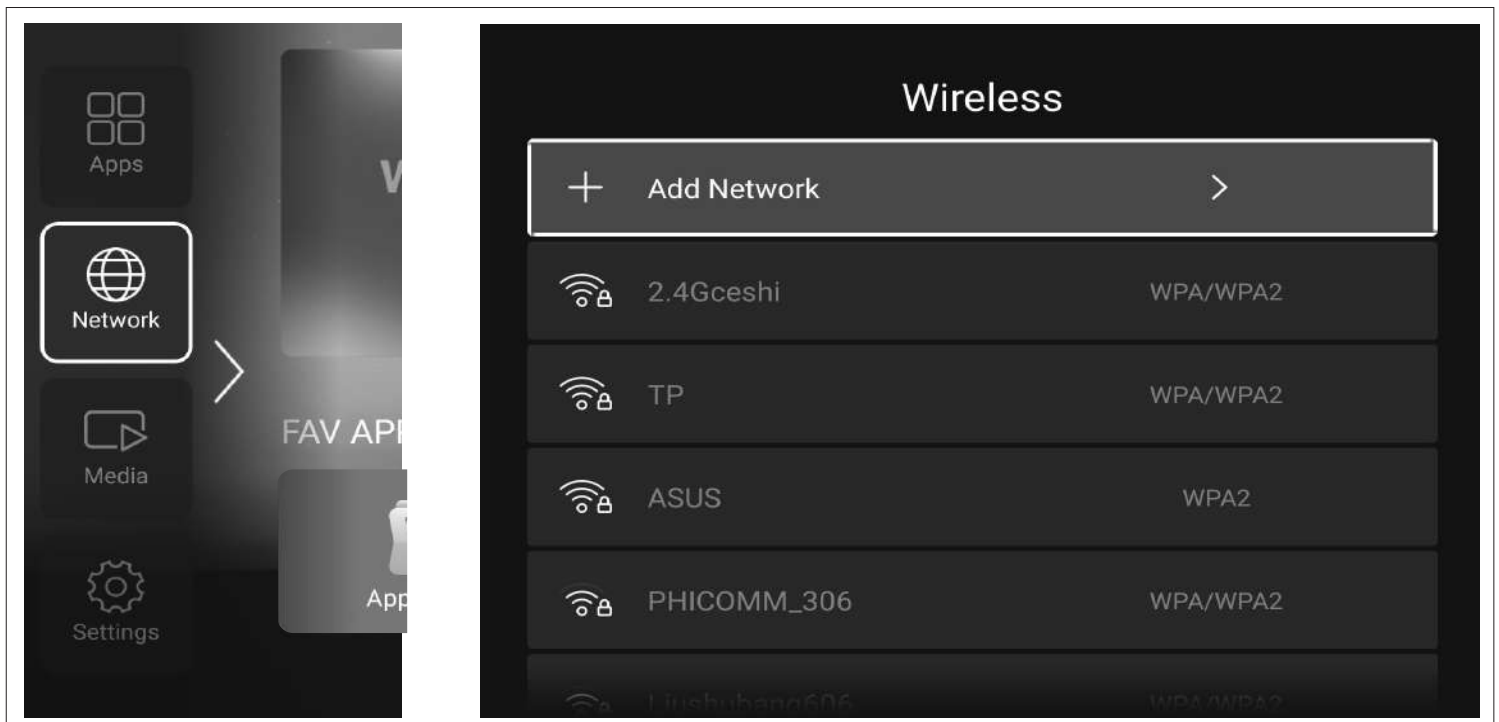

5. Using MaxhubShare

Step 1: On the main interface, navigate to and select the "MaxhubShare" option.

Step 2: In the MaxhubShare interface, scan the QR code displayed on the right side using your mobile device to download and install the "MaxhubShare" application.



6. Using Miracast (Android Users)

Step 1: Open the settings menu on your Android phone/tablet.

Step 2: Access the display setting.

Step 3: Select the name of the "Miracast" receiver (For instance the TV name "TV-****" that is displayed on the projector's interface)

Miracast steps:

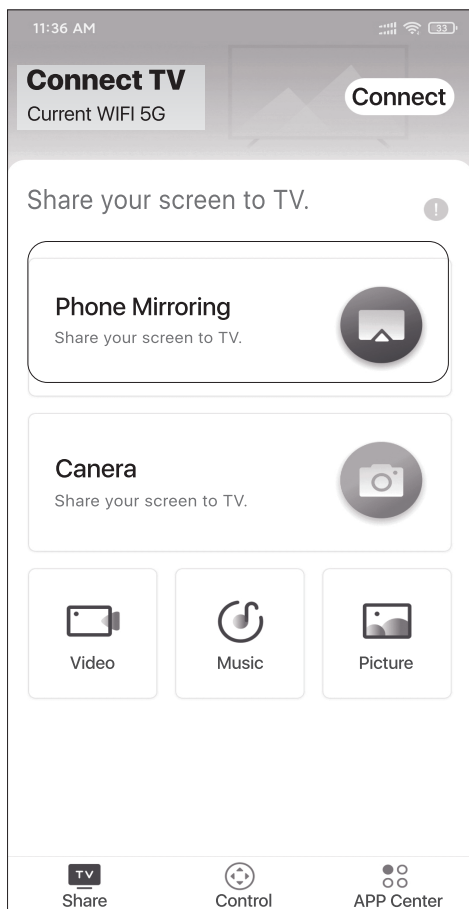

1

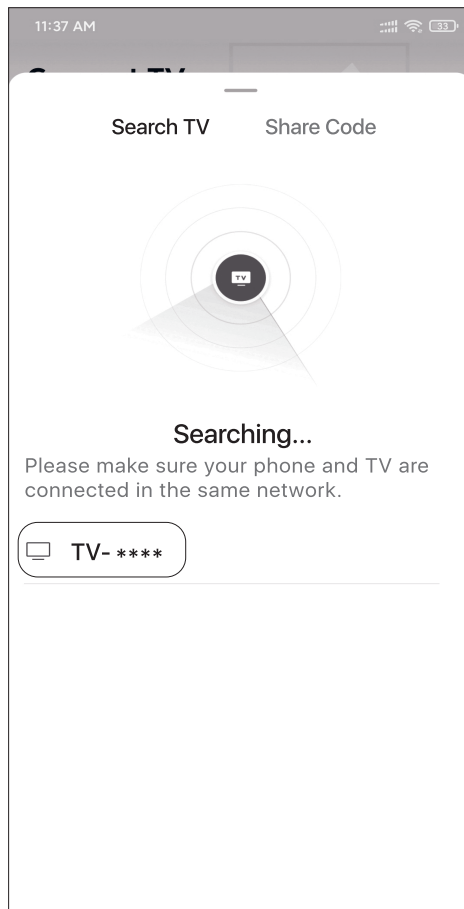

2

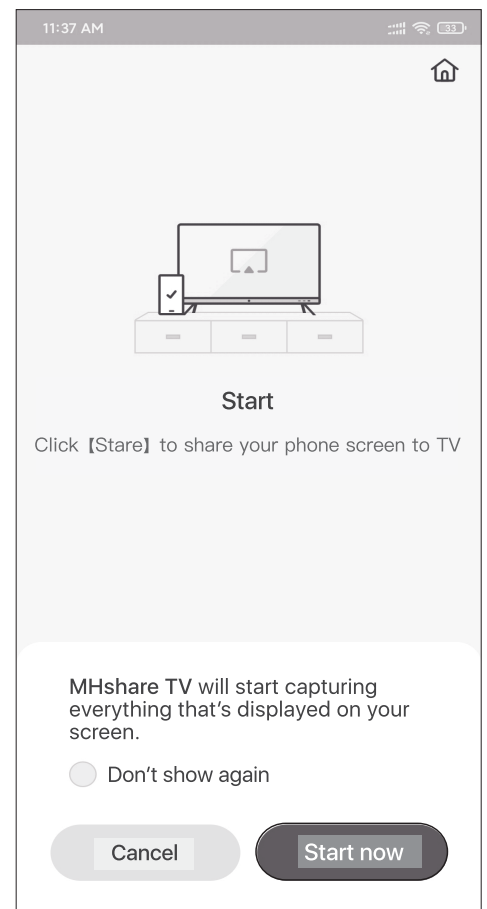

3

7. IOS Cast

Step 1: Open the Control Center on your IOS device and tap screen mirroring.

Step 2: Search for your device.

Step 3: Select the device name "TV-****" from the list to connect.

IOS Cast steps:

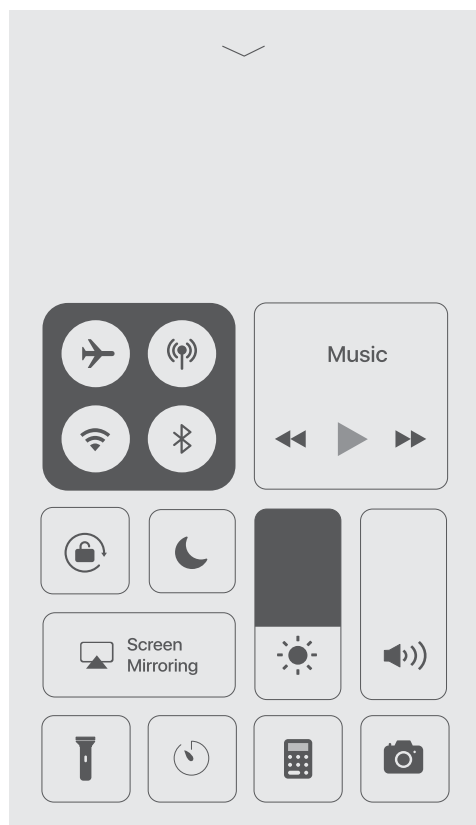

1



2



3

Note: The TV name indicated in the pictures is for the sake of the example and can differ from your TV name.

Bluetooth Connection

To connect audio devices to the projector via Bluetooth follow these steps.

Step 1: On the home page of user interface select "Settings".

Step 2: Enable the Bluetooth connection.

Step 3: Search for the name of the audio device and tap to connect.

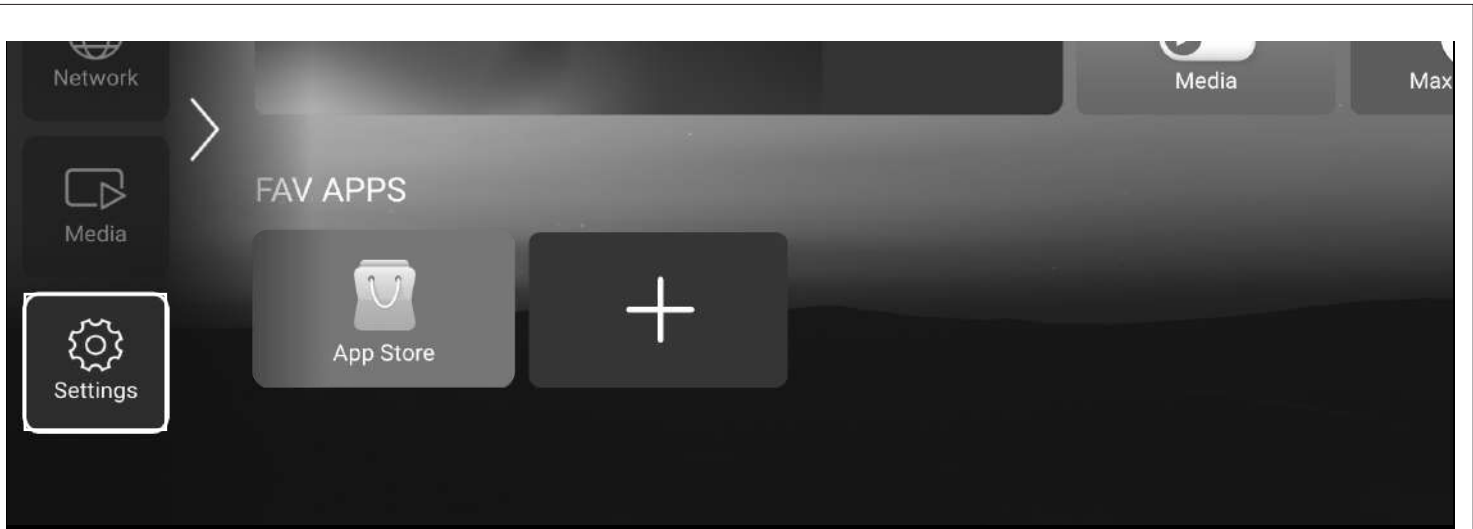

1



2

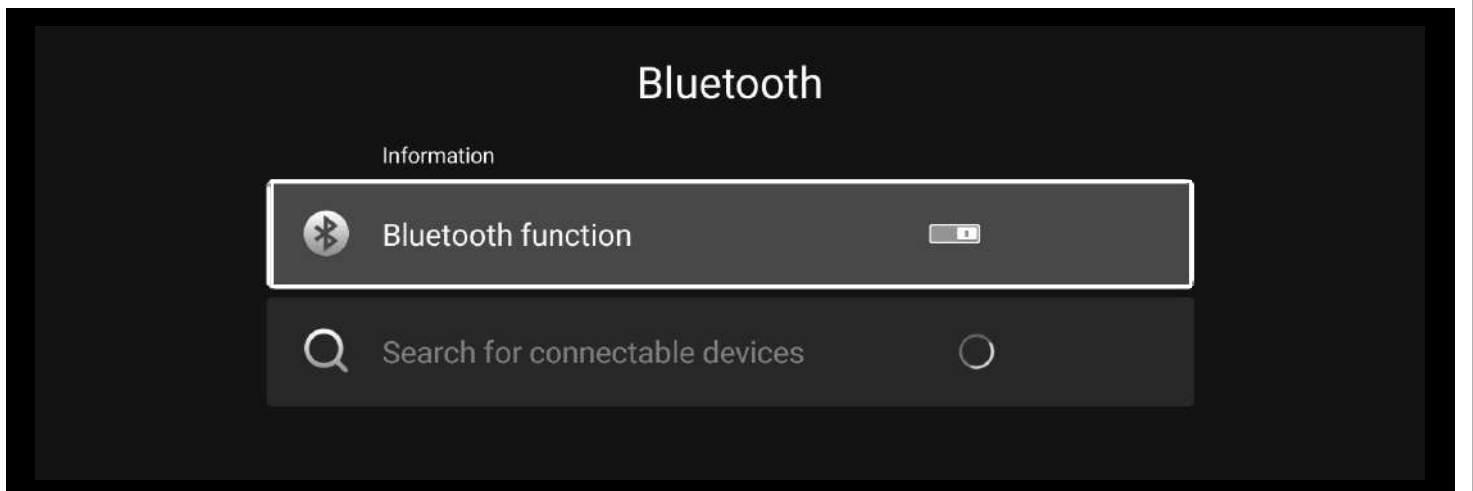

3

Projection Settings

Step 1: To enter the settings menu, select the "Settings" icon located on the left side of the main interface and press the "OK" button on the remote controller.

Step 2: Within the settings menu, navigate to and select "Projection Settings" and choose the desired projection mode.

1. Four-Sided Trapezoid Correction

Step 1: To perform advanced correction, navigate to and select the "Sides" mode.

Step 2: Tap the "Four-sided trapezoid" and modify settings as prompted on the screen.

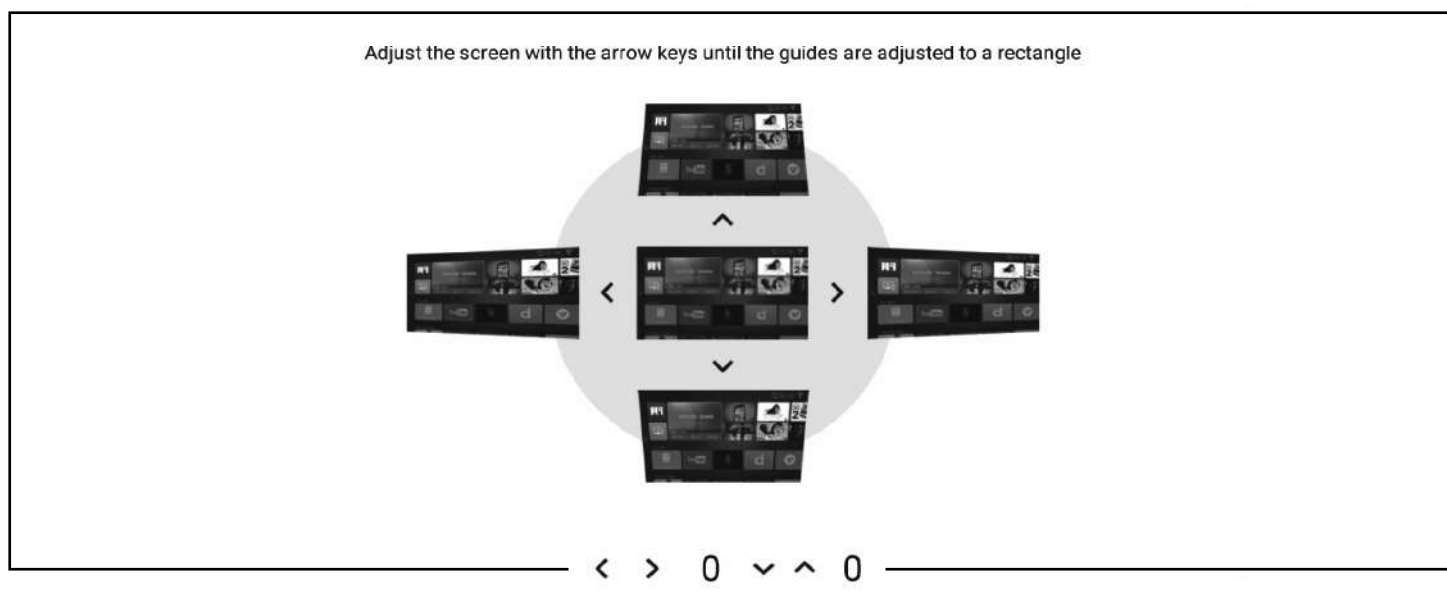
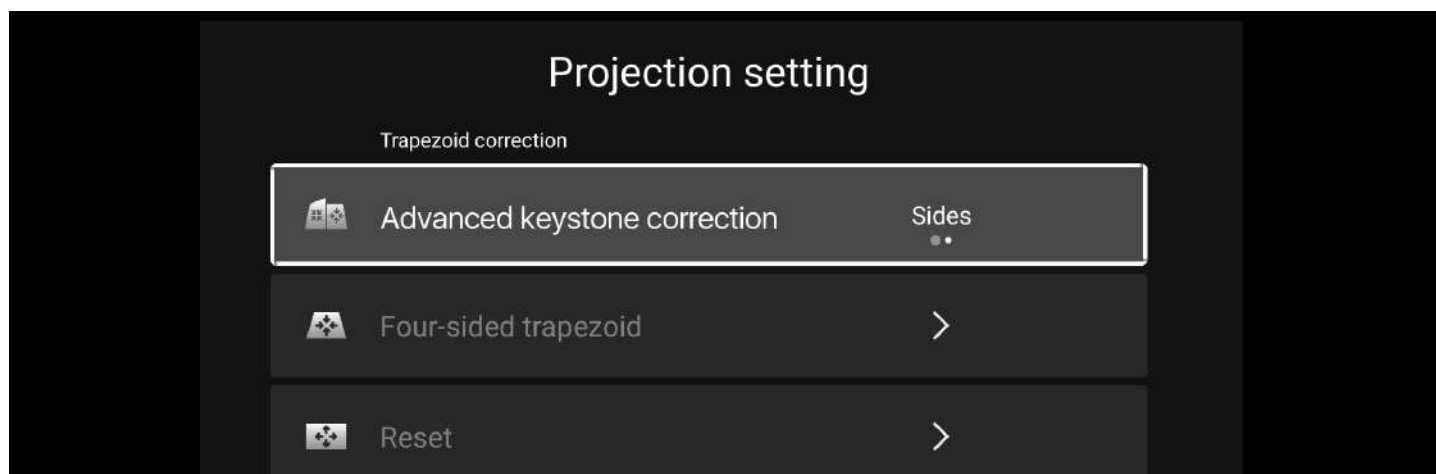

2. Square Trapezoid Correction

Step 1: To perform advanced correction, select the "Corners" mode from the options.

Step 2: Choose "Square trapezoid" and proceed to adjust as guided by the on-screen prompts.

Projection setting

Trapezoid correction



Advanced keystone correction

Corners



Square trapezoid



Reset



Use the arrow keys to adjust the screen until the guides form a perfect rectangle. Press OK to select a different corner point.



Ensure the screen scale corresponds with the system settings by adjusting until the central circle forms a perfect circle.

3. Customized Zoom

Upon start-up, choose the appropriate zoom setting to modify the screen size according to your preferences.

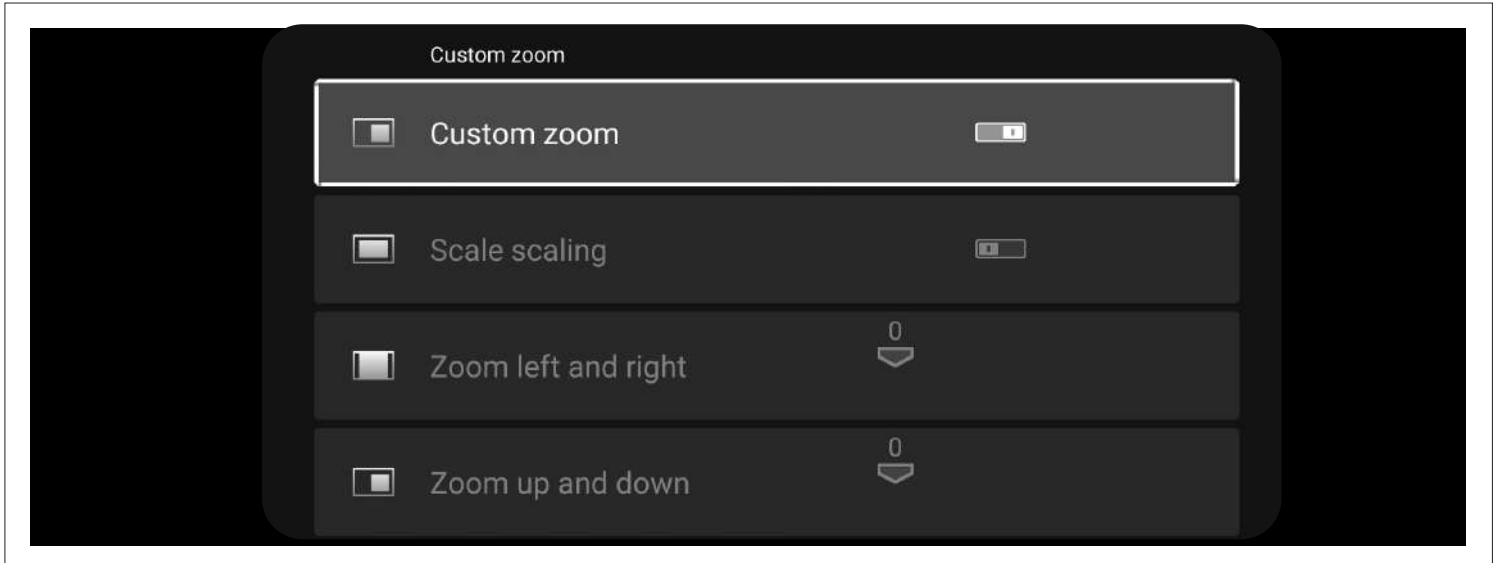

4. Projection Method

Choose from four configurations: Front/Ceiling, Front/Rear, Ceiling/Rear, to suit the specific setup requirements.

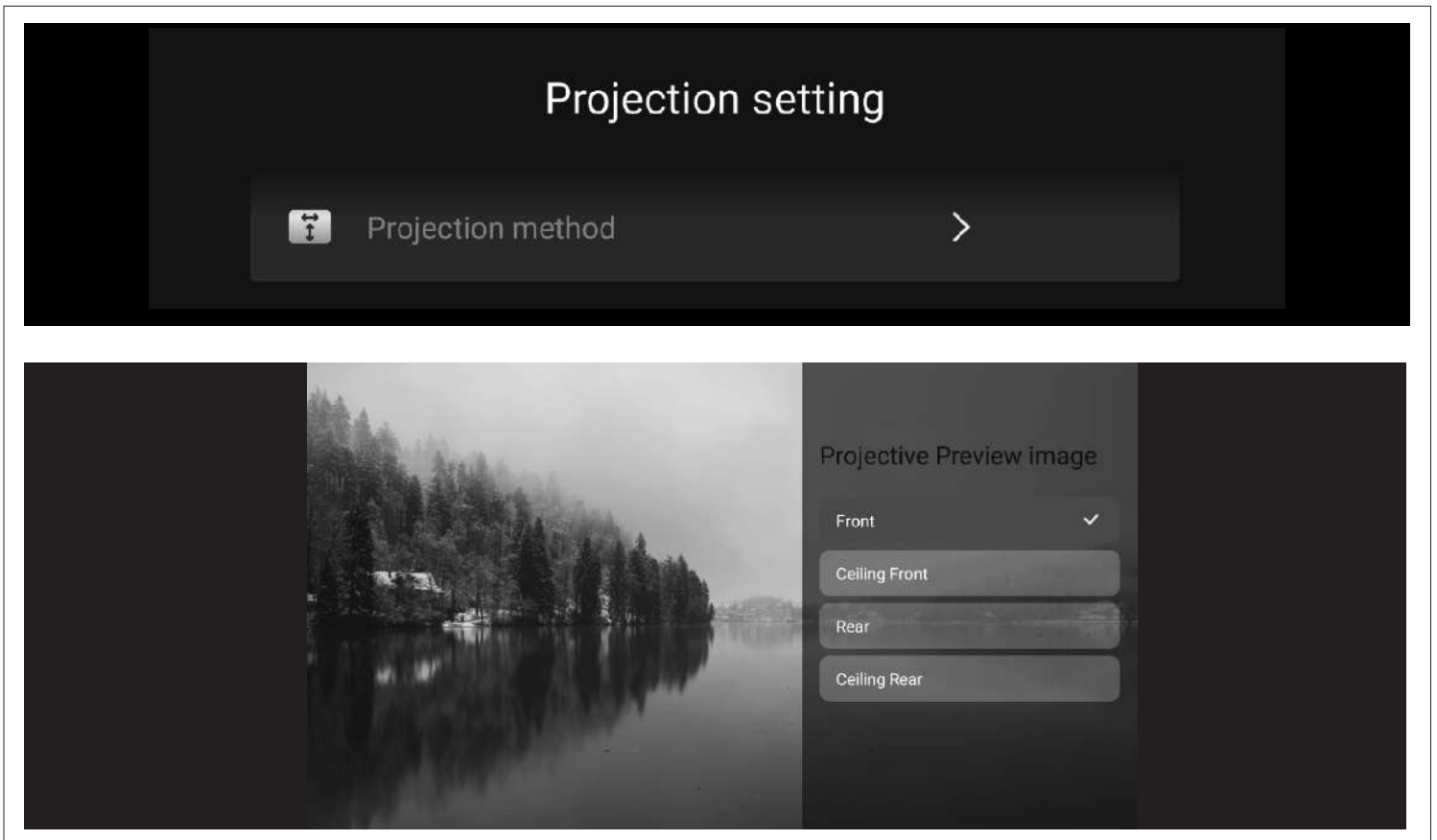

Warranty

Products that you buy directly from our Porodo website or shop come with a 24-month warranty.

When you buy Porodo products from any of our approved sellers, you only get a 12-month warranty. If you want to extend this warranty, go to our website at <https://porodo.net/warranty> and fill out the form with your information. Don't forget to upload a picture of the product too. After we've checked and accepted your request, we'll send you an email to confirm that your product's warranty has been extended.

For more info, please check:
porodo.net/warranty

Contact Us

If you have any questions about this Privacy Policy, please contact us at:
info@porodo.net

Website: porodo.net

Service Support: support@porodo.net

Instagram: [porodo](https://www.instagram.com/porodo)